



## Using a Photron FASTCAM APX RS High-Speed Camera with MiDAS DA

Date Published: March 2010

Revised: December 2012

### Abstract

This application note describes the hardware connections and software settings for using MiDAS DA software with a Photron FASTCAM APX RS model high-speed video camera running Photron PFV (Photron FASTCAM Viewer) software. Included in this document are the settings for putting the camera into Slave/External Sync mode.

### Instructions

1. Connect the Photron FASTCAM APX RS camera cable to the connector labeled **I/O PORT** on the back of the camera. Locate the MiDAS DA breakout box connector labeled **Sync Out**. Connect a BNC coaxial cable from **Sync Out** to the camera cable connector labeled **Sync In**. Locate the MiDAS DA breakout box connector labeled **Trigger**. Connect a BNC cable from **Trigger** to the camera cable connector labeled **Trigger TTL-IN** or **Trigger SW-IN**, as shown on the following page.

*Note: If you are using an external TTL pulse, connect to Trigger TTL-IN. If you are using the mouse (software) trigger inside MiDAS DA, connect to Trigger TTL-IN. If you have both devices connected to a hand switch, use Trigger SW-IN.*

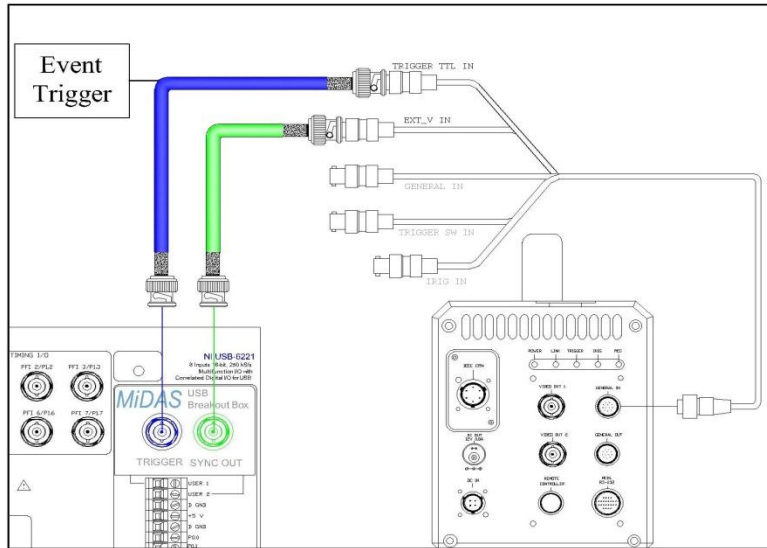

2. Launch the Photron PFV software. Under Option on the menu bar, select **Configuration**. Navigate to Record Options and select **Direct Start** under Type of record mode. Make sure that the box for Loop Record is **not** checked.

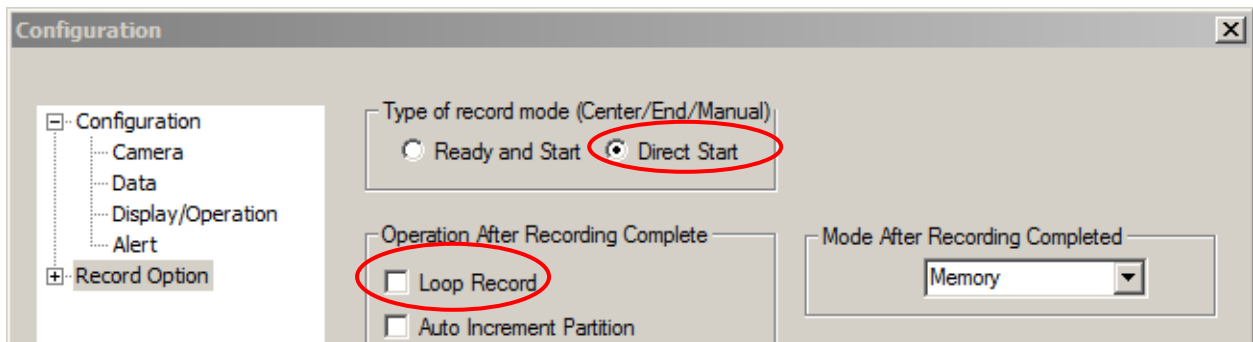

3. Note how long the recording will be by checking the value at the top left corner of the screen as shown below.

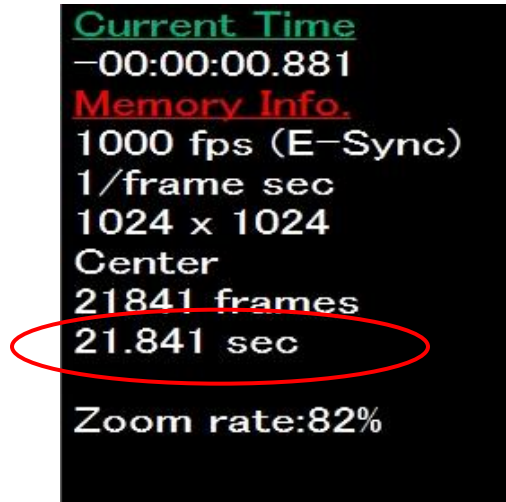

4. Launch MiDAS DA and configure the number and type of sensor input channels.

*Note: For more information on configuring your data channels please refer to the MiDAS DA User Guide.*

5. In MiDAS DA, set the recording duration (Buffer Size) to be greater than the recording length you noted in the PFV software. Use the slider bar or enter a value in the Trigger Percentage field to match the trigger percentage set in the PFV software. Set the Post Trigger Duration to be greater than in the PFV software. Enter the desired video rate in the Sync Out Rate (Hz) field, and the samples per frame in the samples/frame field. Select a Trigger Type from the dropdown menu to be the same type as in PFV, as shown on the following page.

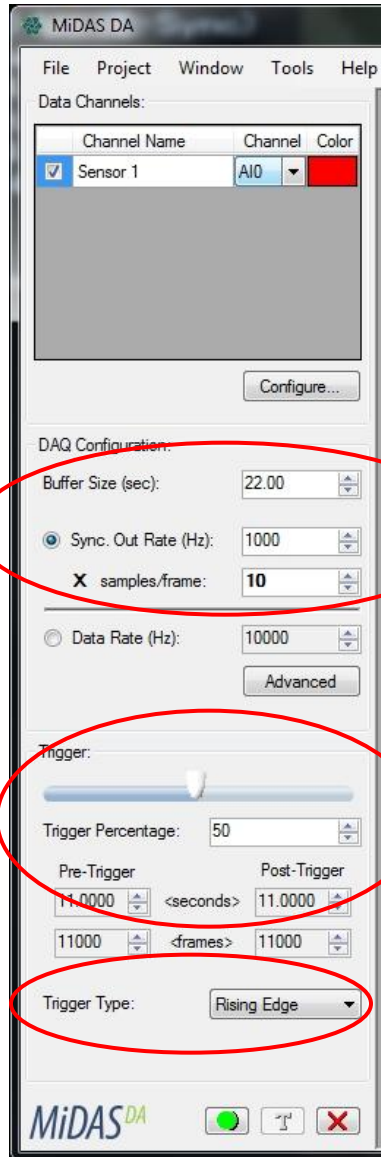

- In MiDAS DA, click the green **Record**  button at the bottom left-hand corner of the window. MiDAS DA will start the data acquisition and also begin sending sync pulses to the camera.
- Click the **Camera Option** button. Under the I/O section, select a trigger type for the TRIG TTL IN field. Select **ON OTHERS POS** in the SYNC IN field, as shown below.

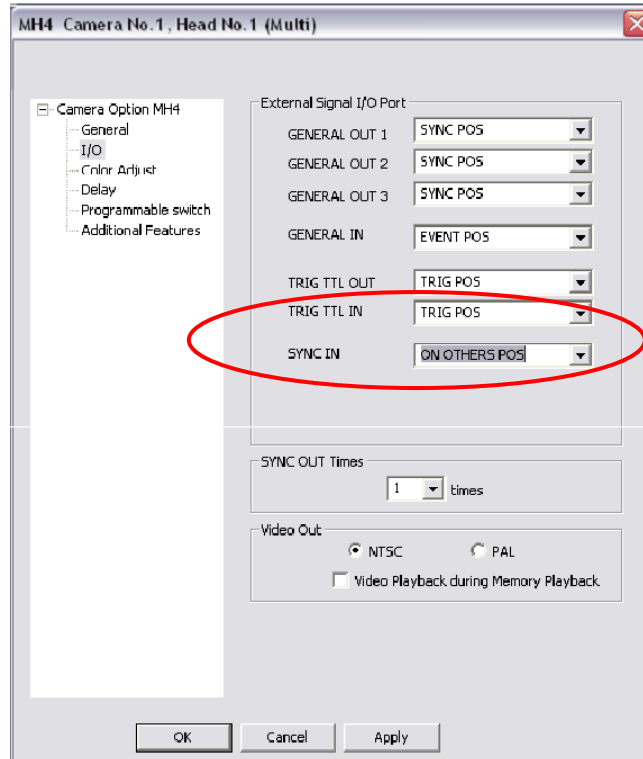

- Under the Camera tab, click the **Trigger Mode** button. Set the trigger mode to **Start, Center, End** or **Manual**, as shown below.

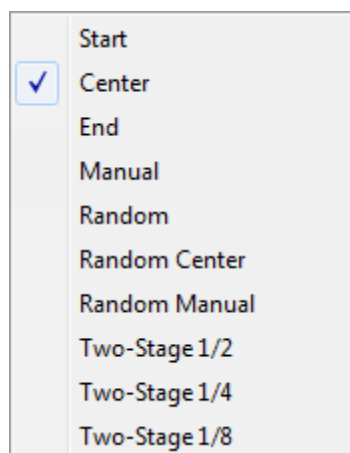

9. In the PFV software, click the **Record**  button.

10. Trigger your data recording either by clicking the **Trigger**  button in MiDAS DA or by using an external trigger.

*Note: For more information regarding triggering in MiDAS DA, consult the MiDAS DA User Guide.*

11. After recording, trim the video length to the specific frames that you wish to use with MiDAS DA. Save the video to a hard drive.

12. Import your video into MiDAS DA either by dragging and dropping it into the MiDAS DA workspace or by clicking **File ► Project ► Add Video** from the menu bar. Once your video is imported, the Playback window will appear. Click the **Play**  button to simultaneously play your synchronized video and data.

---

This camera connection guide is copyrighted by Xcitex Inc. and is supplied without specific warranty to any purpose and based on information currently available at the time of this writing. All specifications stated herein are subject to change without notice.

For further information on Xcitex products, visit [www.xcitex.com](http://www.xcitex.com) or send an email to [info@xcitex.com](mailto:info@xcitex.com).

Xcitex Inc.  
25 First Street, Suite 105  
Cambridge, MA 02141 USA

© 2012 Xcitex Inc.

